

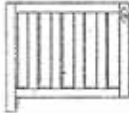











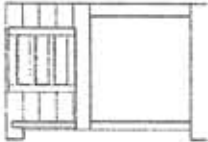
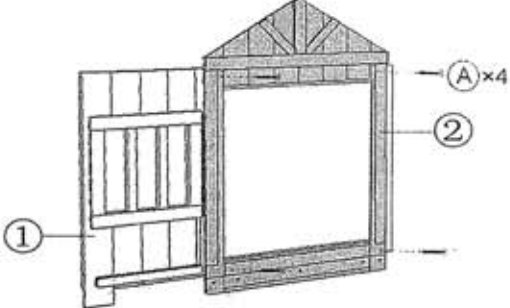
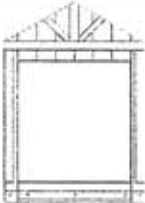

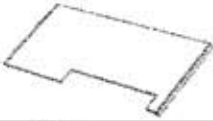
		14		2PCS	
		15		1PC	
		A		3.5*25	24PCS
		B		3.5*30	20PCS
		C		3.5*40	8PCS
1		1PC	 <p>Schritt 1</p>		
2		1PC			
3		2PCS			
4		1PC			
5		1PC			
6		1PC	 <p>Schritt 2</p>		
7		1PC			
8		2PCS			
9		2PCS			
10		2PCS			
11		1PC	 <p>Schritt 3</p>		
12		2PCS			
13		2PCS			
					 <p>Schritt 4</p>

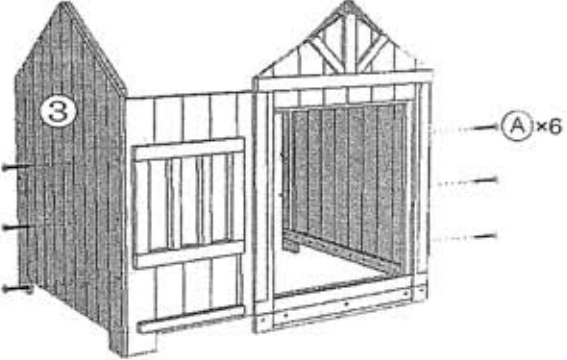

Schritt 5

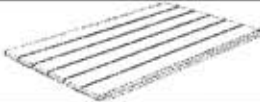

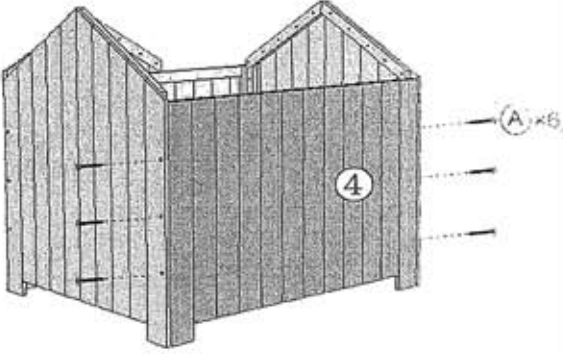
Schritt 6

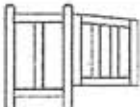
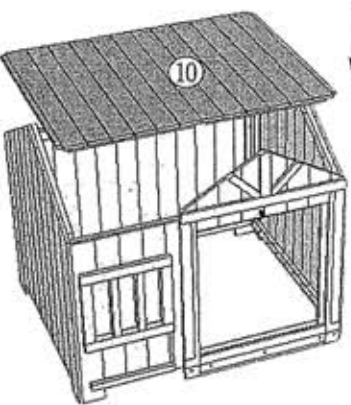
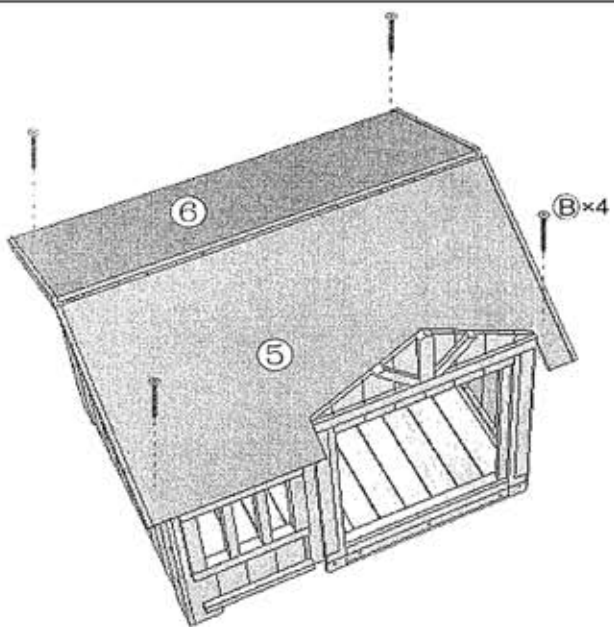
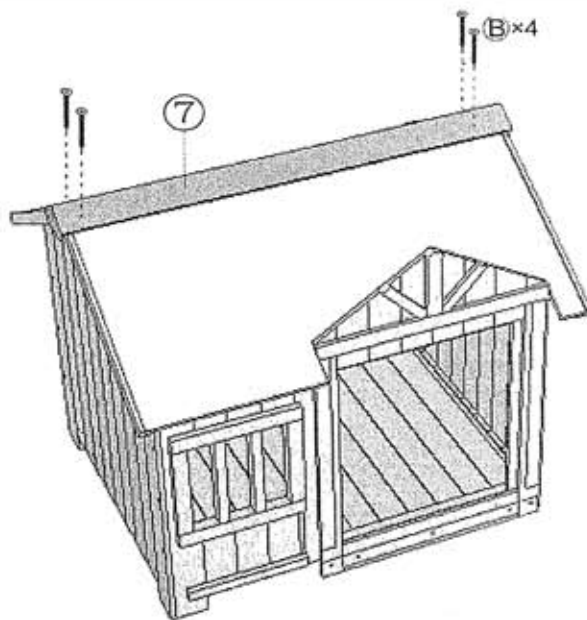
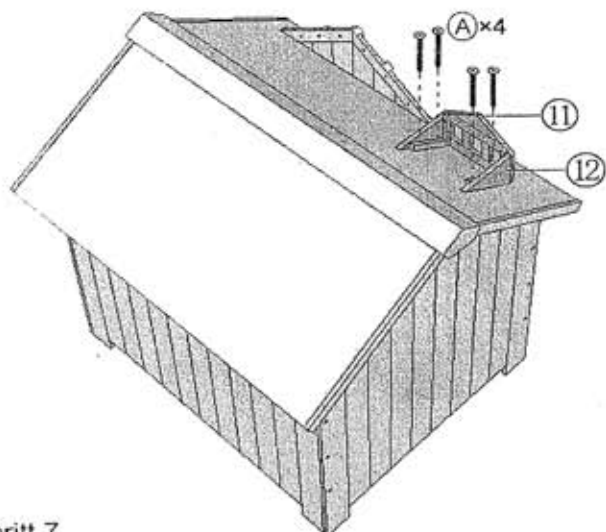

Schritt 7

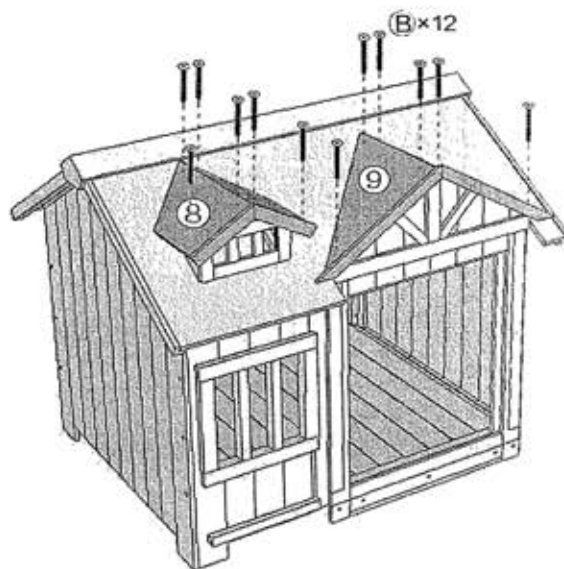

Schritt 8

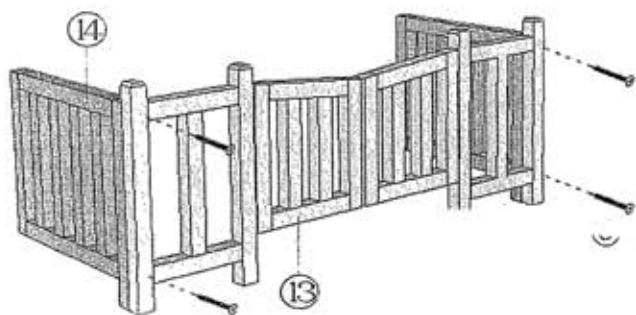

Schritt 9

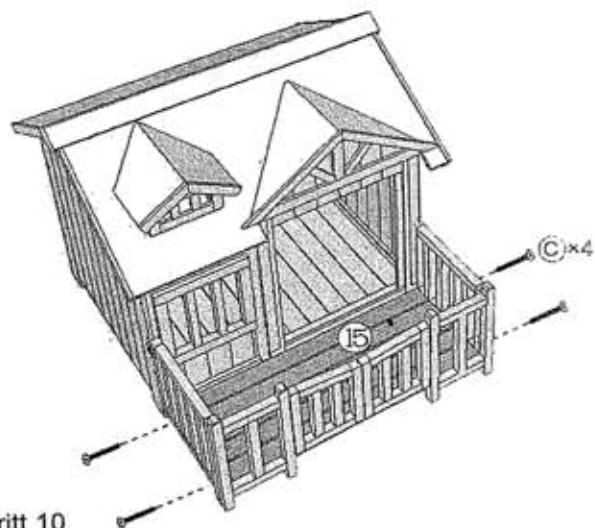

Schritt 10